

## 1A, 50V - 600V Glass Passivated Super Fast Rectifiers

### FEATURES

- High efficiency, low VF
- High current capability
- High reliability
- Low power loss
- Compliant to RoHS Directive 2011/65/EU and in accordance to WEEE 2002/96/EC
- Halogen-free according to IEC 61249-2-21



### MECHANICAL DATA

**Case:** DO-204AL (DO-41)

Molding compound, UL flammability classification rating 94V-0

Part no. with suffix "H" means AEC-Q101 qualified

Packing code with suffix "G" means green compound (halogen-free)

**Terminal:** Pure tin plated leads, solderable per JESD22-B102

Meet JESD 201 class 2 whisker test

**Weight:** 0.35 g (approximately)

**DO-204AL (DO-41)**

| MAXIMUM RATINGS AND ELECTRICAL CHARACTERISTICS (T <sub>A</sub> =25°C unless otherwise noted) |                                      |              |        |        |        |        |        |        |        |      |      |
|--|--------------------------------------|--------------|--------|--------|--------|--------|--------|--------|--------|------|------|
| PARAMETER  | SYMBOL                               | SF 11G       | SF 12G | SF 13G | SF 14G | SF 15G | SF 16G | SF 17G | SF 18G | UNIT |      |
| Maximum repetitive peak reverse voltage  | V <sub>RRM</sub>                     | 50           | 100    | 150    | 200    | 300    | 400    | 500    | 600    | V    |      |
| Maximum RMS voltage  | V <sub>RMS</sub>                     | 35           | 70     | 105    | 140    | 210    | 280    | 350    | 420    | V    |      |
| Maximum DC blocking voltage  | V <sub>DC</sub>                      | 50           | 100    | 150    | 200    | 300    | 400    | 500    | 600    | V    |      |
| Maximum average forward rectified current  | I <sub>F(AV)</sub>                   | 1            |        |        |        |        |        |        |        | A    |      |
| Peak forward surge current, 8.3 ms single half sine-wave superimposed on rated load          | I <sub>FSM</sub>                     | 30           |        |        |        |        |        |        |        | A    |      |
| Maximum instantaneous forward voltage (Note 1) @ 1 A   | V <sub>F</sub>                       | 0.95         |        |        | 1.3    |        | 1.7    |        |        | V    |      |
| Maximum reverse current @ rated V <sub>R</sub> T <sub>J</sub> =25°C<br>T <sub>J</sub> =125°C | I <sub>R</sub>                       | 5            |        |        |        |        | 100    |        |        |      | μA   |
| Maximum reverse recovery time (Note 2)   | t <sub>rr</sub>                      | 35           |        |        |        |        |        |        |        |      | ns   |
| Typical junction capacitance (Note 3)  | C <sub>J</sub>                       | 20           |        |        | 10     |        |        |        |        | pF   |      |
| Typical thermal resistance   | R <sub>θJL</sub><br>R <sub>θJA</sub> | 20           |        |        |        |        | 80     |        |        |      | °C/W |
| Operating junction temperature range   | T <sub>J</sub>                       | - 55 to +150 |        |        |        |        |        |        |        | °C   |      |
| Storage temperature range  | T <sub>STG</sub>                     | - 55 to +150 |        |        |        |        |        |        |        | °C   |      |

Note 1: Pulse Test with PW=300μs, 1% Duty Cycle

Note 2: Reverse Recovery Test Conditions: I<sub>F</sub>=0.5A, I<sub>R</sub>=1.0A, I<sub>RR</sub>=0.25A

Note 3: Measured at 1 MHz and Applied Reverse Voltage of 4.0V D.C.

| ORDERING INFORMATION |                 |              |                         |         |                                  |
|----------------------|-----------------|--------------|-------------------------|---------|----------------------------------|
| PART NO.             | PART NO. SUFFIX | PACKING CODE | PACKING CODE SUFFIX (*) | PACKAGE | PACKING                          |
| SF1xG<br>(Note 1)    | H               | A0           | G                       | DO-41   | 3,000 / Ammo box (52mm taping)   |
|                      |                 | R0           |                         | DO-41   | 5,000 / 13" Paper reel           |
|                      |                 | R1           |                         | DO-41   | 5,000 / 13" Paper reel (Reverse) |
|                      |                 | B0           |                         | DO-41   | 1,000 / Bulk packing             |

Note 1: "x" defines voltage from 50V (SF11G) to 600V (SF18G)

\*: Optional available

| EXAMPLE       |          |                 |              |                     |                                   |
|---------------|----------|-----------------|--------------|---------------------|-----------------------------------|
| PREFERRED P/N | PART NO. | PART NO. SUFFIX | PACKING CODE | PACKING CODE SUFFIX | DESCRIPTION                       |
| SF18GHA0G     | SF18G    | H               | A0           | G                   | AEC-Q101 qualified Green compound |

**RATINGS AND CHARACTERISTICS CURVES**

(T<sub>A</sub>=25°C unless otherwise noted)

FIG.1 MAXIMUM AVERAGE FORWARD CURRENT DERATING

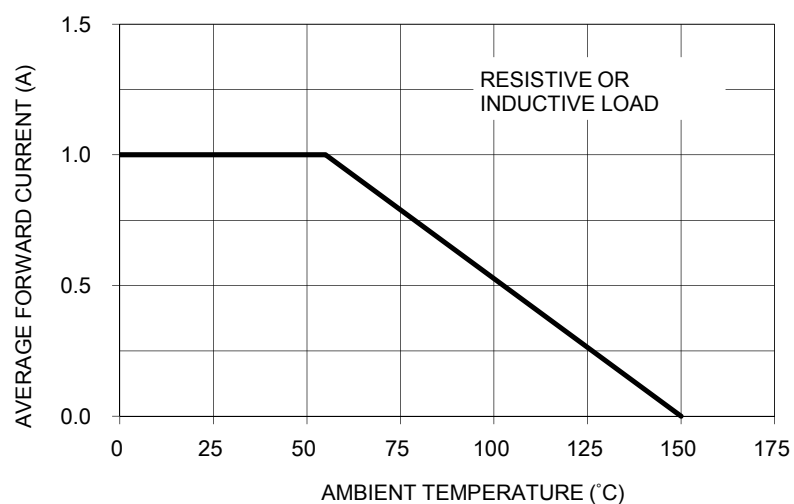

FIG.2 TYPICAL REVERSE CHARACTERISTICS

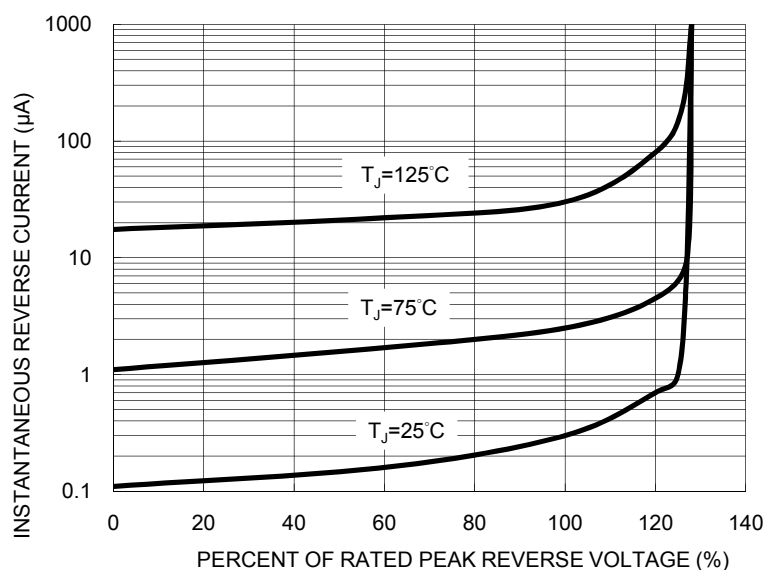

FIG.3 MAXIMUM NON-REPETITIVE FORWARD SURGE CURRENT

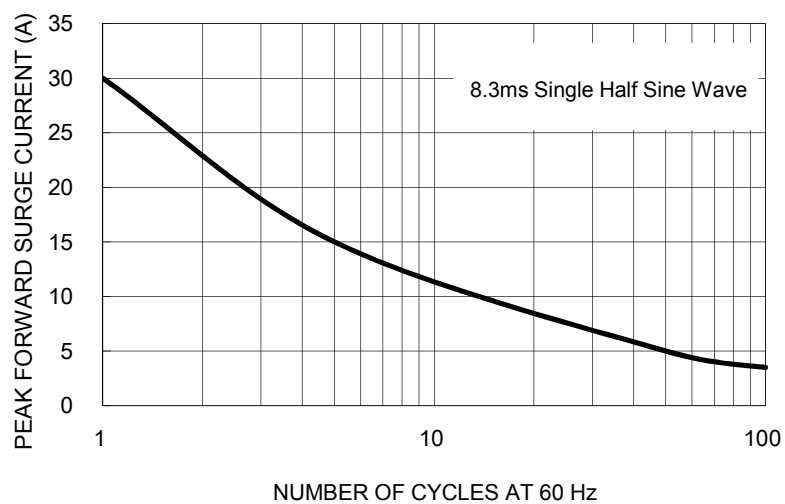

FIG.4 TYPICAL FORWARD CHARACTERISTICS

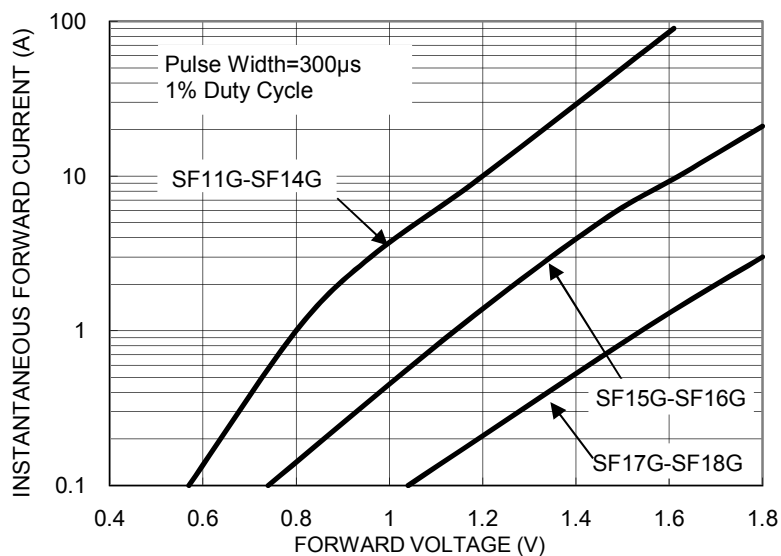

FIG. 5 TYPICAL JUNCTION CAPACITANCE

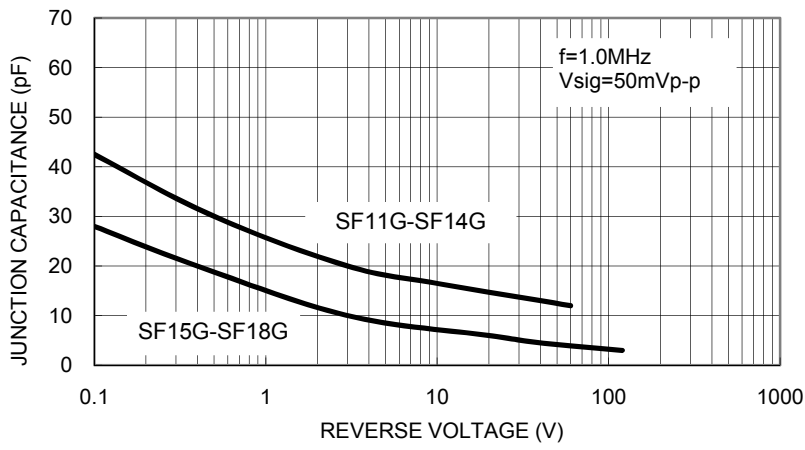
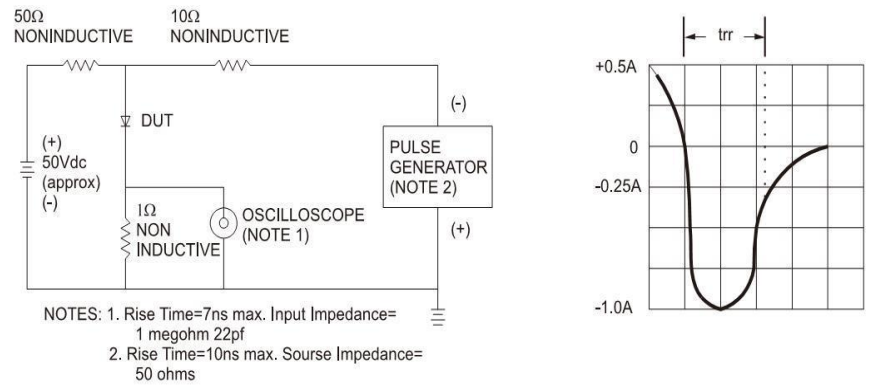
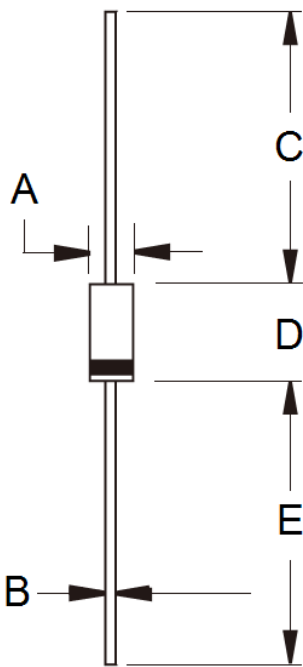

FIG.6 REVERSE RECOVERY TIME CHARACTERISTIC AND TEST CIRCUIT DIAGRAM



PACKAGE OUTLINE DIMENSIONS

DO-204AL (DO-41)



| DIM. | Unit (mm) |      | Unit (inch) |       |
|------|-----------|------|-------------|-------|
|      | Min       | Max  | Min         | Max   |
| A    | 2.00      | 2.70 | 0.079       | 0.106 |
| B    | 0.71      | 0.86 | 0.028       | 0.034 |
| C    | 25.40     | -    | 1.000       | -     |
| D    | 4.20      | 5.20 | 0.165       | 0.205 |
| E    | 25.40     | -    | 1.000       | -     |

MARKING DIAGRAM



P/N = Specific Device Code  
 G = Green Compound  
 YWW = Date Code  
 F = Factory Code

## Notice

Specifications of the products displayed herein are subject to change without notice. TSC or anyone on its behalf, assumes no responsibility or liability for any errors or inaccuracies.

Information contained herein is intended to provide a product description only. No license, express or implied, to any intellectual property rights is granted by this document. Except as provided in TSC's terms and conditions of sale for such products, TSC assumes no liability whatsoever, and disclaims any express or implied warranty, relating to sale and/or use of TSC products including liability or warranties relating to fitness for a particular purpose, merchantability, or infringement of any patent, copyright, or other intellectual property right.

The products shown herein are not designed for use in medical, life-saving, or life-sustaining applications. Customers using or selling these products for use in such applications do so at their own risk and agree to fully indemnify TSC for any damages resulting from such improper use or sale.