

**QT-Brightek Lamp with Housing Series**  
**5mm Round Bi-color Lamp with Housing**  
**Part No.: QBL8XXXX60D-MP6\_series**

---

**Table of Contents:**

Introduction .....	3
Electrical / Optical Characteristic (Ta=25 °C) .....	4
Absolute Maximum Rating .....	4
Characteristic Curves.....	5
Labeling .....	8
Ordering Information .....	8
Revision History .....	9
Disclaimer .....	9

## Introduction

**Feature:**

- White Diffused lens
- Packaged in bulk pack
- 5mm round TH lamp with housing
- GaAsP technology for Yellow, Red
- GaP technology for Yellow-Green
- Viewing angle: 60° typ.

**Description:**

These 5mm round type lamps with housing is easy to mount on the panels.

**Application:**

- General purpose indicator application
- Electronic instrument

**Certification & Compliance:**

- TS16949
- ISO9001
- RoHS Compliant



**Dimension:**

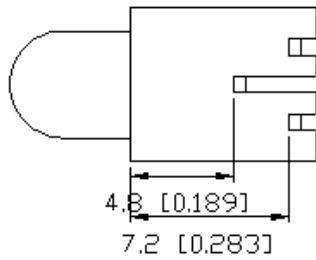

Note:

1. First Color Anode
2. Common Cathode
3. Second Color Anode

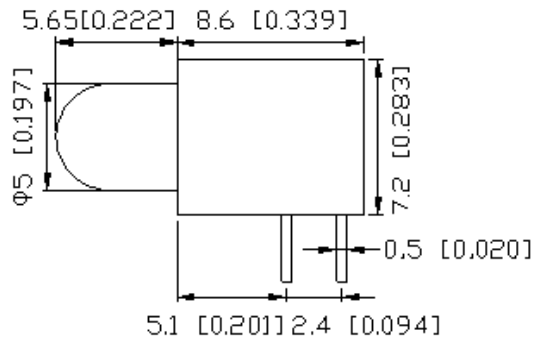
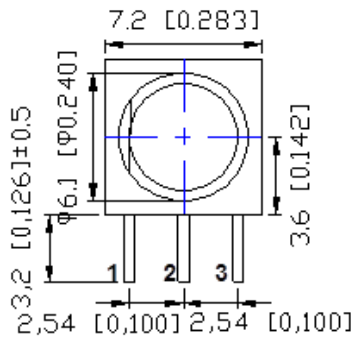

Units: mm / general tolerance = +/-0.5mm unless otherwise specified

**Electrical / Optical Characteristic (Ta=25°C)**

Product	Color	I <sub>F</sub> (mA)	V <sub>F</sub> (V)		λ <sub>D</sub> (nm)			I <sub>V</sub> (mcd)	
			Typ.	Max.	Min.	Typ.	Max.	Min.	Typ.
QBL8RAYG60D-MP6	GaAsP Red	20	2.0	2.6	--	630	--	9	20
	GaP Green	20	2.2	2.6	--	570	--	13	30
QBL8RAYA60D-MP6	GaAsP Red	20	2.0	2.6	--	630	--	9	20
	Yellow	20	2.0	2.6	--	588	--	9	20
QBL8YGYA60D-MP6	GaP Green	20	2.2	2.6	--	570	--	13	30
	Yellow	20	2.0	2.6	--	588	--	9	20

**Absolute Maximum Rating**

Material	P <sub>d</sub> (mW)	I <sub>F</sub> (mA)	I <sub>FP</sub> (mA)*	V <sub>R</sub> (V)	T <sub>OP</sub> (°C)	T <sub>ST</sub> (°C)	T <sub>SOL</sub> (°C)**
AlGaAs	60	25	100	5	-40 to +80	-40 to +85	260
GaAsP	78	30	100	5	-40 to +80	-40 to +85	260
GaP	78	30	100	5	-40 to +80	-40 to +85	260

\*Duty=0.1, 0.1ms Pulse Width

\*\*Wave Soldering for no more than 3 sec @ 260 °C

## Note:

Tolerance of measurement of forward voltage: ±0.1V

Tolerance of measurement of luminous intensity: ±15%

Tolerance of measurement of dominant wavelength: ±2nm

**Characteristic Curves**

GaAsP Red

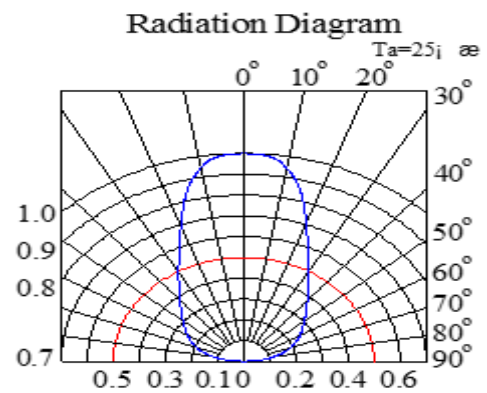
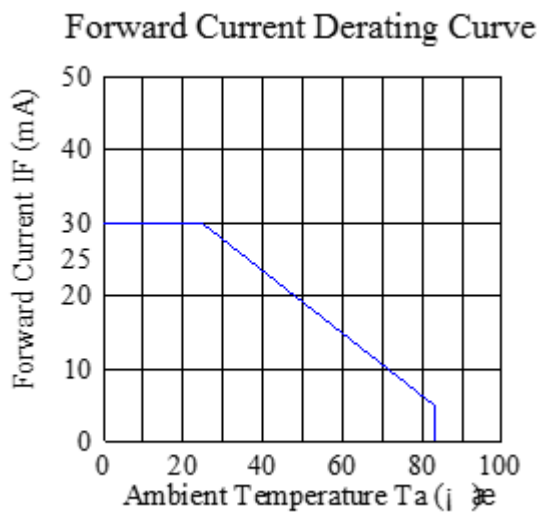
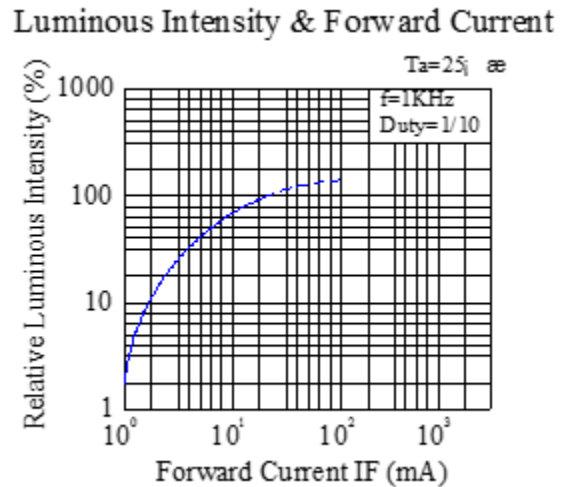
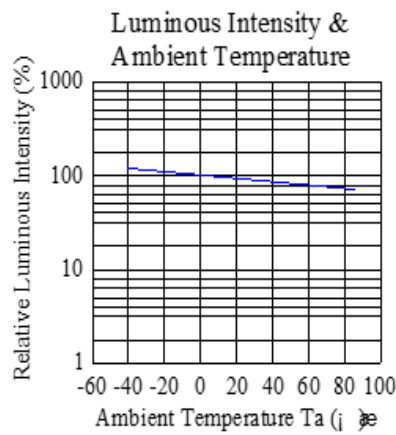
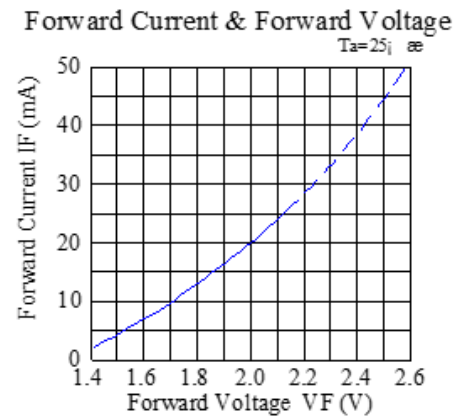
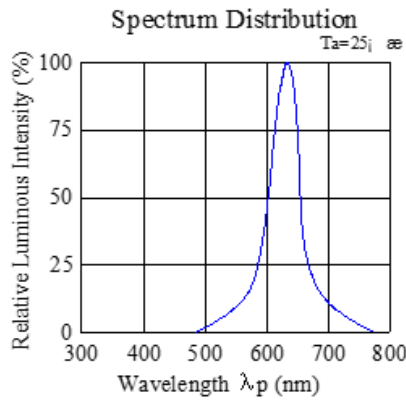



GaP Yellow-Green

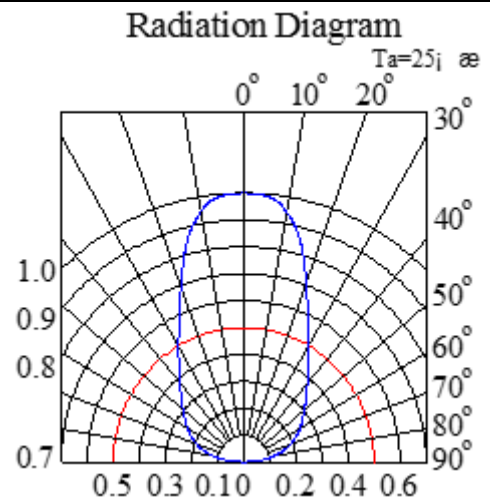
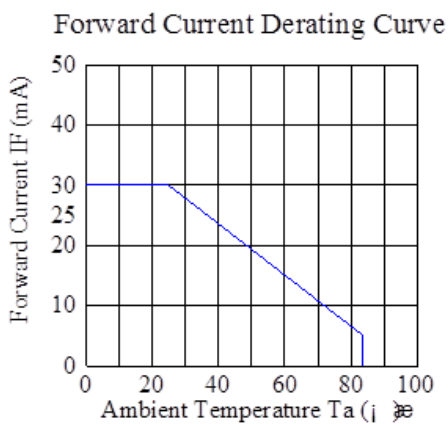
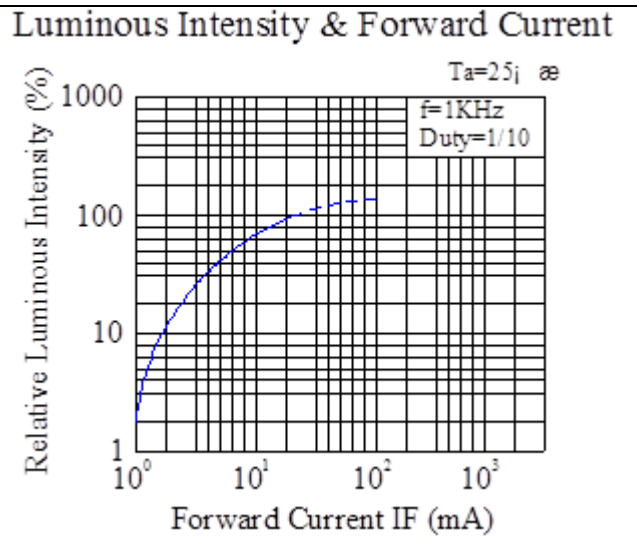
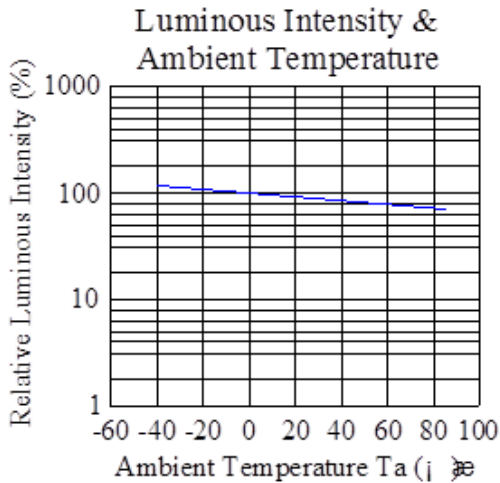
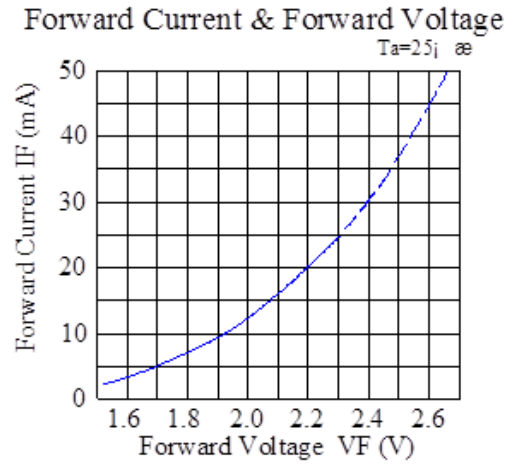
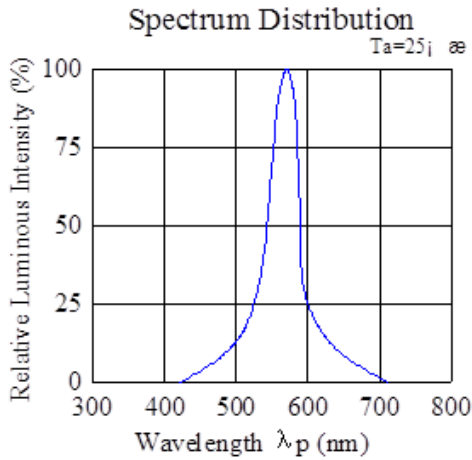

**Labeling**

Part No: \_\_\_\_\_

Customer P/N: \_\_\_\_\_

Item: \_\_\_\_\_

Q'ty: \_\_\_\_\_

Vf: \_\_\_\_\_

Iv: \_\_\_\_\_

WI: \_\_\_\_\_

Date: \_\_\_\_\_

**Made in China****Ordering Information**

Part #	Orderable Part #	Spec Range	Quantity per bag
QBL8RAYG60D-MP6	QBL8RAYG60D-MP6	Iv=13mcd typ. @ 20mA, $\lambda_D=630\text{nm}$ typ.; Iv=20mcd typ. @ 20mA, $\lambda_D=570\text{nm}$ typ.	500
QBL8RAYA60D-MP6	QBL8RAYA60D-MP6	Iv=13mcd typ. @ 20mA, $\lambda_D=630\text{nm}$ typ.; Iv=13mcd typ. @ 20mA, $\lambda_D=588\text{nm}$ typ.	500
QBL8YGYA100D-MP6	QBL8YGYA100D-MP6	Iv=20mcd typ. @ 20mA, $\lambda_D=570\text{nm}$ typ.; Iv=13mcd typ. @ 20mA, $\lambda_D=588\text{nm}$ typ.	500



---

## Revision History

Description:	Revision #	Revision Date
New Release of QBL8XXXX60D-MP6_series	V1.0	06/24/2016



## Disclaimer

QT-BRIGHTTEK reserves the right to make changes without further notice to any products herein to improve reliability, function or design. QT-BRIGHTTEK does not assume any liability arising out of the application or use of any product or circuit described herein; neither does it convey any license under its patent rights, nor the rights of others.

## Life Support Policy

QT-BRIGHTTEK's products are not authorized for use as critical components in life support devices or systems without the express written approval of QT-BRIGHTTEK. As used herein:

1. Life support devices or systems are devices or systems which, (a) are intended for surgical implant into the body, or (b) support or sustain life, and (c) whose failure to perform when properly used in accordance with instructions for use provided in the labeling, can be reasonably expected to result in a significant injury of the user.
2. A critical component in any component of a life support device or system whose failure to perform can be reasonably expected to cause the failure of the life support device or system, or to affect its safety or effectiveness.