

HIGH-RELIABILITY PRODUCTS

Features

- Input Voltage Range from 1.6V to 6.0V
- 150mV Maximum Dropout @ 1A
- Adjustable Output from 0.5V with $\pm 1\%$ Accuracy
- High PSRR (76dB Typical at 1.8V_{in} to 0.5V_o, 1A)
- Noise Bypass Pin
- Programmable Soft-Start
- 12 μ A Quiescent Current in Shutdown
- Enable Input
- Power Good Indicator
- Over Current and Over Temperature Protection
- Reverse Blocking from Output to Input
- Military Temperature Range: -55°C to +125°C
- 3mm x 3mm x 1mm MLPD-8 Package
- Fully WEEE and RoHS Compliant

Applications

- Noise-sensitive rails
- FPGA power
- Embedded systems
- Avionics

Description

The SC4212LM is a high performance linear regulator designed for applications requiring very low dropout voltage at load currents up to 1 Ampere. It operates with V_{IN} as low as 1.6V and up to 6V, making it useful for a wide range of different applications and rails. The output voltage is programmable down to 0.5V, set via an external resistor divider, or to a fixed setting of 0.5V depending upon how the FB pin is configured.

The SC4212LM has an enable pin to further reduce power dissipation while shut down. This device also offers an active-high power good for the system to check the output voltage. An external soft start capacitor can be connected to the SS pin to program the profile of the startup. Additionally, the device provides protection features such as over current protection, over temperature protection and reverse blocking from output to input. A capacitor at the BYP pin can bypass the noise generated in the internal bandgap reference in order to improve the PSRR and the noise at the output. The SC4212LM is available in a 3mm x 3mm MLPD-8 package.

Typical Application Circuit

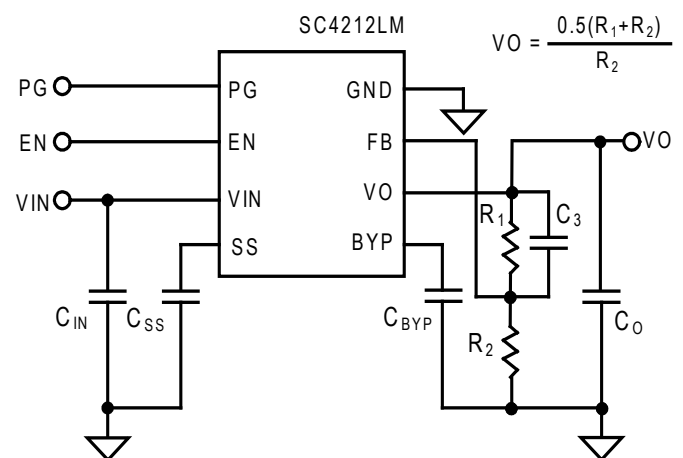
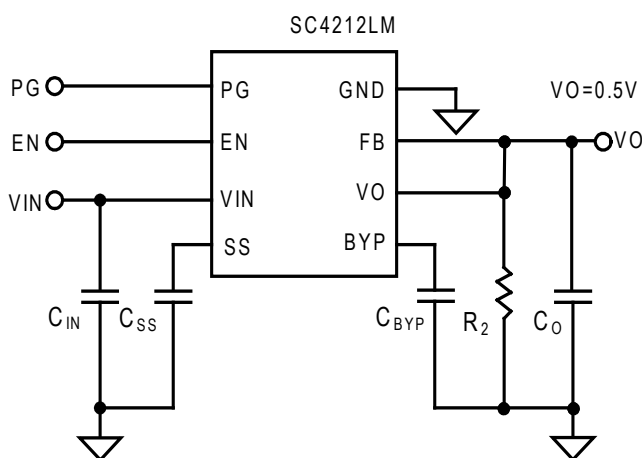

* C₃ is a placeholder

Pin Configuration

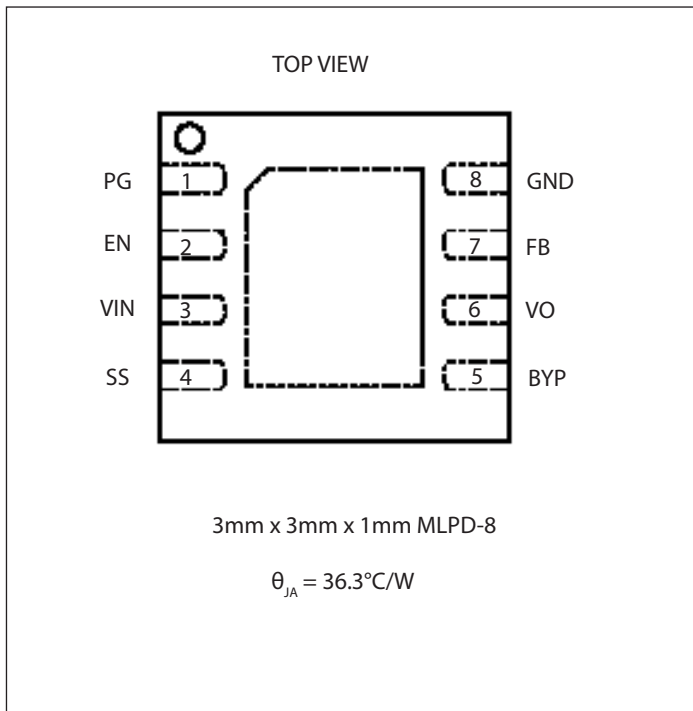

Ordering Information

Device	Package
SC4212LMMLTRC ⁽¹⁾⁽²⁾	3mm x 3mm x 1mm MLPD-8
SC4212LEVB ⁽³⁾	Evaluation Board

Notes:

- (1) Available in tape and reel only. A reel contains 3,000 devices.
- (2) Available in lead-free package only. Device is WEEE and RoHS compliant and halogen free.
- (3) This EVB comes populated with the industrial temperature grade device.

Marking Information

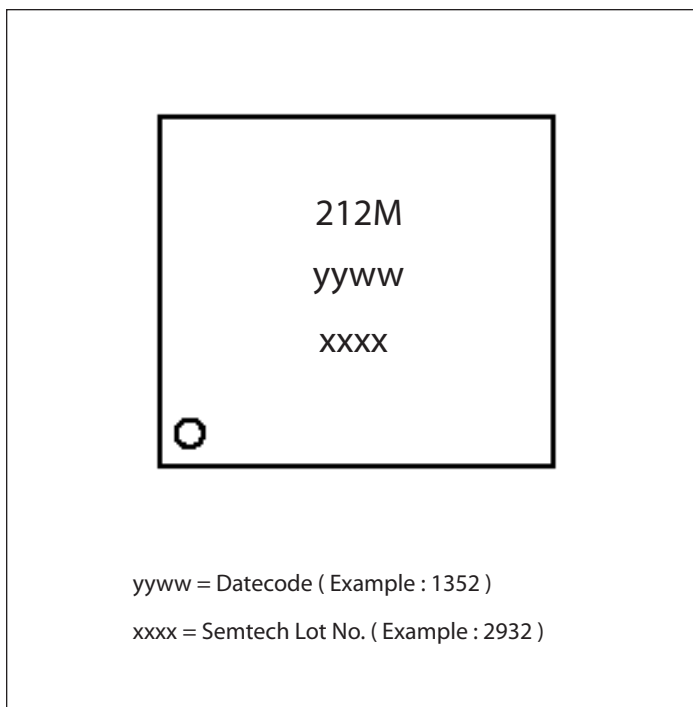

Absolute Maximum Ratings

V _{IN} , V _O , PG to GND (V)	-0.3 to 6.5
EN, SS, BYP to GND (V)	-0.3 to V _{IN} + 0.3
FB to GND (V)	-0.3 to V _{IN} + 0.3
Power Dissipation	Internally Limited
ESD Protection Level HBM ⁽¹⁾ (kV)	4
ESD Protection Level CDM ⁽²⁾ (kV)	1

Recommended Operating Conditions

V _{IN} (V)	1.6 ≤ V _{IN} ≤ 6.0
Junction Temperature Range (°C)	-55 ≤ T _J ≤ +125
Output Current Range	50 μA ≤ I _O ≤ 1A

Thermal Information

Thermal Resistance, Junction to Ambient ⁽³⁾ (°C/W) ..	36.3
Thermal Resistance, Junction to Case (°C/W)	3.77
Storage Temperature (°C)	-65 to +150
Peak IR Reflow Temperature (10s to 30s)	+260

Exceeding the above specifications may result in permanent damage to the device or device malfunction. Operation outside of the parameters specified in the Electrical Characteristics section is not recommended.

NOTES:

- (1) Tested according to standard ANSI/ESDA/JEDEC JS-001-2012.
- (2) Tested according to standard JESD-C101E.
- (3) Calculated from package in still air, mounted to 3" x 4.5", 4 layer FR4 PCB with thermal vias under the exposed pad per JESD51 standards.

Electrical Characteristics

Unless noted otherwise T_J = 25° C for typical, -55° C ≤ T_J ≤ 125° C for min and max. V_{EN} = V_{IN}, V_{FB} = V_O, V_{IN} = 1.6V to 6.0V, C_{IN} = 10 μF, C_{OUT} = 10 μF, C_{BYP} = 470 nF.

Parameter	Symbol	Conditions	Min	Typ	Max	Units
V_{IN}						
V _{IN} operating range ⁽¹⁾			1.6		6.0	V
Quiescent current	I _Q	V _{IN} = 3.3V, I _O = 0A		325	680	μA
		I _O = 1A			2	mA
		V _{EN} = 0V		12	50	μA
Soft-Start						
Soft-start source current	I _{SS}	V _{IN} = 3.3V		2		μA
t _{SS} without external C _{SS}				250		μs
Feedback						
Feedback voltage ⁽²⁾	V _{FB}	I _O = 10mA to 1A	0.495	0.500	0.505	V
Feedback pin current	I _{FB}	V _{FB} = V _{OUT}		80	200	nA
V_O						
Line regulation ⁽²⁾		I _O = 10mA		0.01	0.2	%/V

Electrical Characteristics (continued)

Parameter	Symbol	Conditions	Min	Typ	Max	Units
Load regulation ⁽²⁾		$I_o = 10\text{mA to } 1\text{A}$		0.21	1.0	%
Dropout voltage ⁽³⁾	V_{DO}	$I_o = 0.5\text{A}$	$1.6\text{V} \leq V_{IN} < 2.2\text{V}$		86	mV
			$2.2\text{V} \leq V_{IN} \leq 6.0\text{V}$		75	
		$I_o = 1\text{A}$	$1.6\text{V} \leq V_{IN} < 2.2\text{V}$		175	
			$2.2\text{V} \leq V_{IN} \leq 6.0\text{V}$		150	
Current limit	I_{CL}		1.2		2.6	A
Power Supply Rejection Ratio	PSRR	$V_{IN} = 1.8\text{V}, V_o = 0.5\text{V}, I_o = 1\text{A}, C_{BYP} = 470\text{nF}$	$f = 100\text{Hz}$		80	dB
			$f = 1\text{kHz}$		76	
			$f = 10\text{kHz}$		64	
			$f = 100\text{kHz}$		43	
			$f = 500\text{kHz}$		32	
			$f = 1\text{MHz}$		26	
EN						
Enable pin current	I_{EN}	$V_{EN} = 0\text{V}, V_{IN} = 1.6\text{V to } 6.0\text{V}$		1.5	10	μA
		$V_{EN} = V_{IN}$		80	200	nA
Enable pin threshold	V_{IH}	$V_{IN} = 1.6\text{V to } 6.0\text{V}$	1.2			V
	V_{IL}				0.4	
Over Temperature Protection						
High trip level	T_{HI}			150		$^{\circ}\text{C}$
Hysteresis	T_{HYST}			10		$^{\circ}\text{C}$
Power Good						
PG threshold		Upper limit, $V_{FB} > \text{internal } 500\text{mV reference}$			110	%
		Lower limit, $V_{FB} < \text{internal } 500\text{mV reference}$	90			
PG pin leakage current		$V_{IN} = 3.3\text{V}$		0.5		μA
PG resistance		$V_{IN} = 3.3\text{V}$		53		Ω

Notes:

(1) Minimum $V_{IN} = V_{OUT} + V_{DO}$ or 1.6V, whichever is greater.

(2) Low duty cycle pulse testing with Kelvin connections required.

(3) $V_{DO} = V_{IN} - V_o$ when $V_{FB} = \text{GND}$.

Pin Descriptions

Pin #	Pin Name	Pin Function
1	PG	Power good output. Open drain, active high. Connect to a positive supply with a pullup resistor. Leave this pin unconnected if not used.
2	EN	Enable input. Driving this pin high turns on the regulator. Driving this pin low shuts off the regulator. If not driven from a control circuit, tie this pin directly to the VIN pin, or via a resistor up to 400k Ω .
3	VIN	Input supply pin. A large bulk capacitance should be placed close to this pin to ensure that the input supply does not sag below the minimum V_{IN} .
4	SS	Soft-start pin. Connecting a ceramic capacitor from this pin to GND sets the startup time. Refer to the EC table (page 3) for the typical t_{SS} with the external soft-start capacitor not populated.
5	BYP	Bypass pin. Low noise performance is optimized by connecting a capacitor from this pin to GND.
6	VO	Regulator output pin. Refer to the Applications Information section for output capacitor selection.
7	FB	Input of the error amplifier. This pin is used to set the output voltage (See typical Application Circuits on page 1).
8	GND	Ground pin.
	THERMAL PAD	The exposed pad enhances thermal performance and is not electrically connected inside the package. It is recommended to connect the exposed pad to the ground plane using multiple vias.

Block Diagram

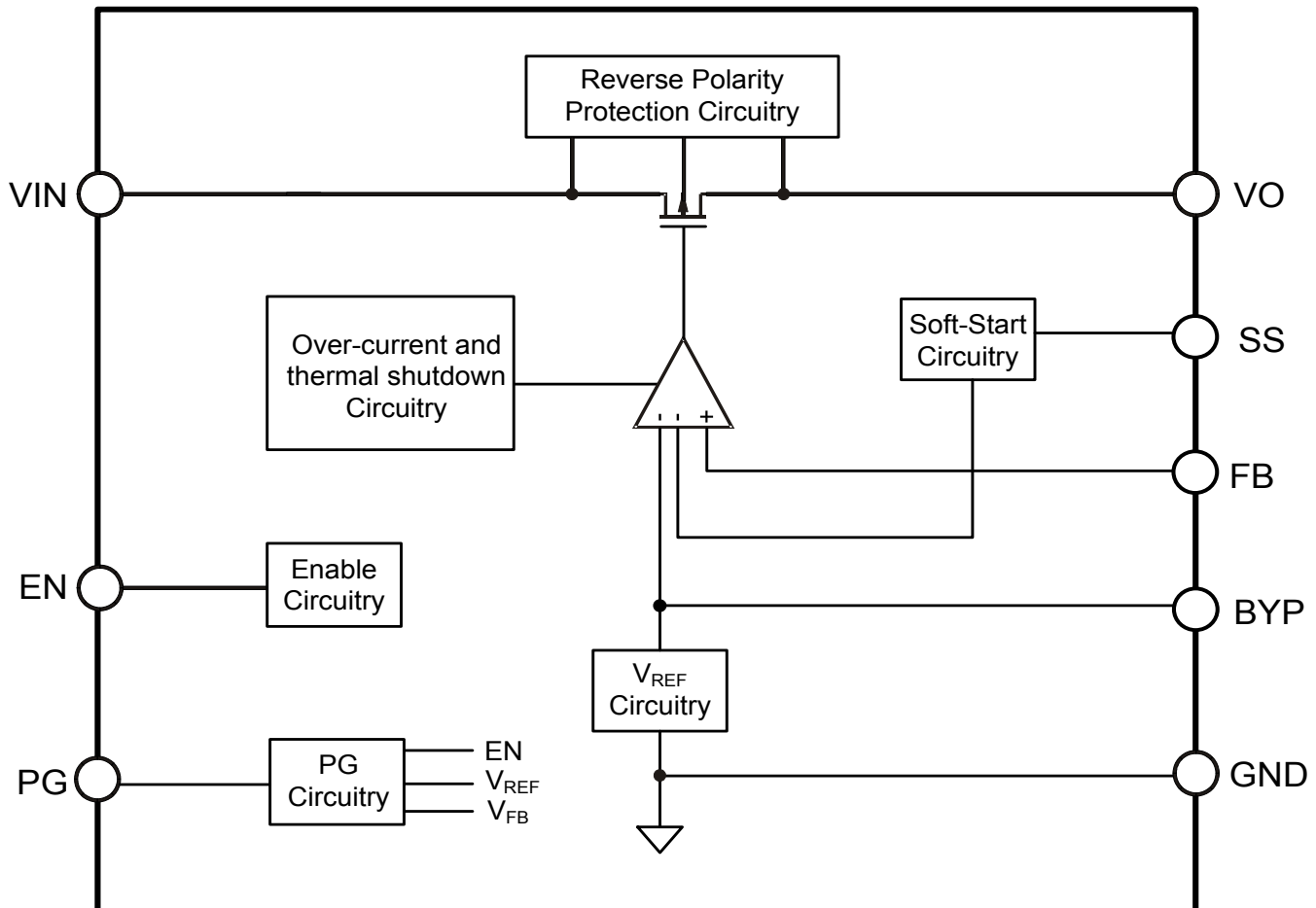

Typical Characteristics

Unless noted otherwise $C_{IN}=10\mu\text{F}/10\text{V X7R 0805}$, $C_{OUT}=10\mu\text{F}/10\text{V X7R 0805}$.

Dropout Voltage at $V_{in} = 1.6\text{V}$

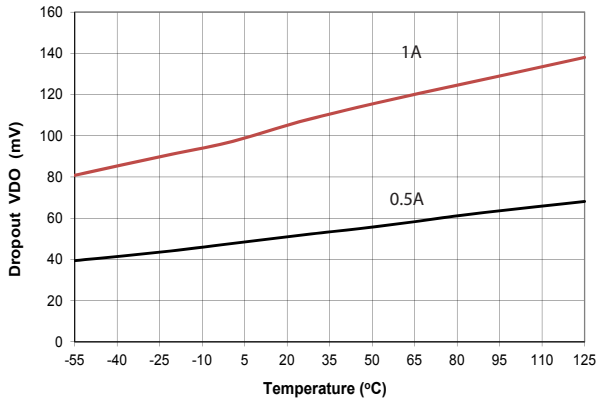

Dropout Voltage at $V_{in} = 2.2\text{V}$

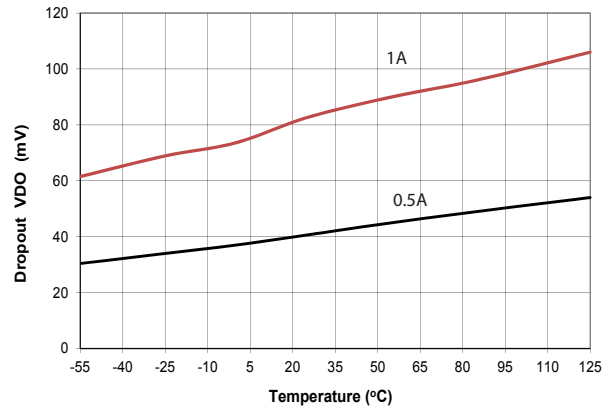

Dropout Voltage at $V_{in} = 6.0\text{V}$

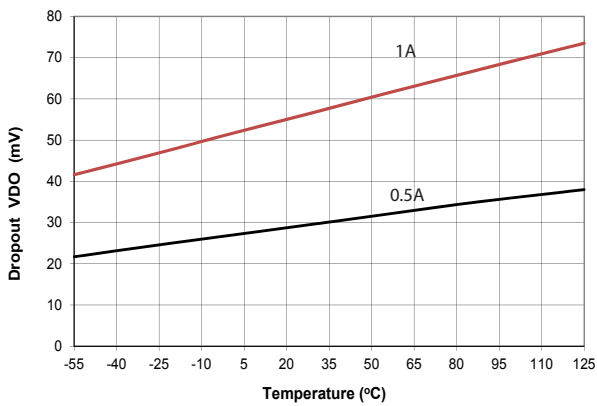

Current Limit Threshold

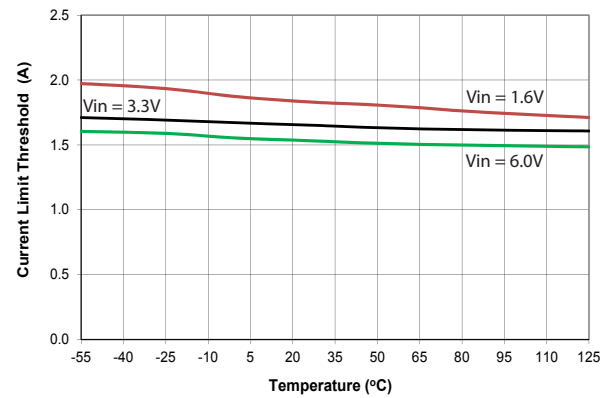

Input Under-voltage Lockout Threshold

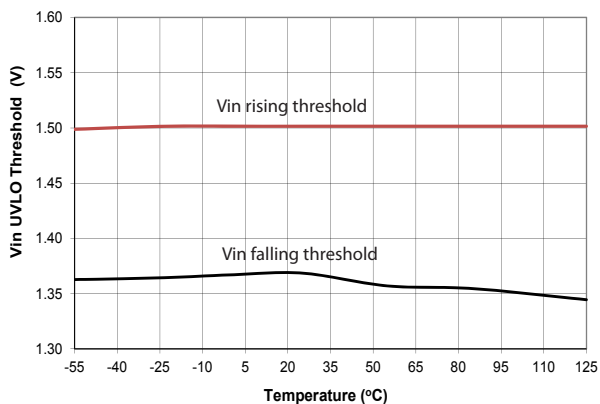

Shutdown Current

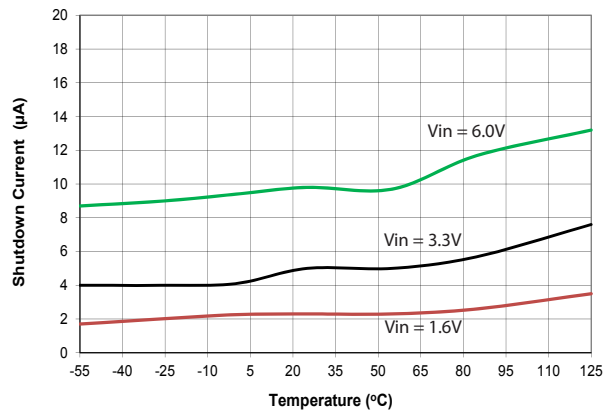

Typical Characteristics (Continued)

Unless noted otherwise $C_{IN}=10\mu F/10V$ X7R 0805, $C_{OUT}=10\mu F/10V$ X7R 0805.

Quiescent Current

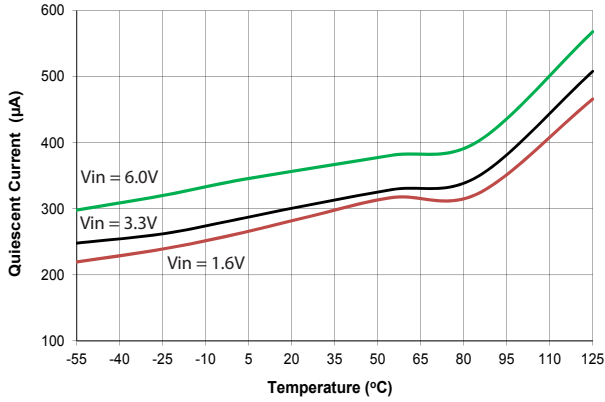

Output Rise Time $C_{SS} = NP$

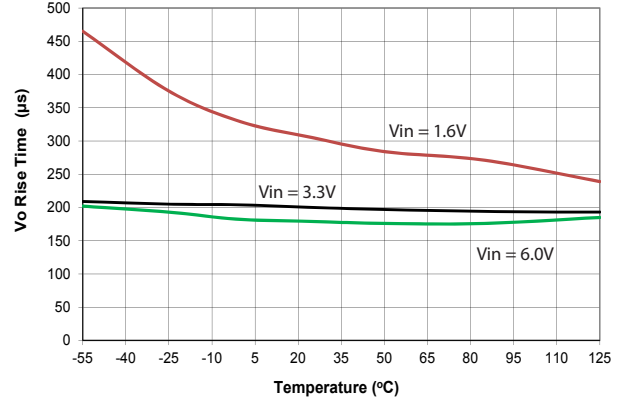

Output Rise Time $C_{SS} = 10nF$

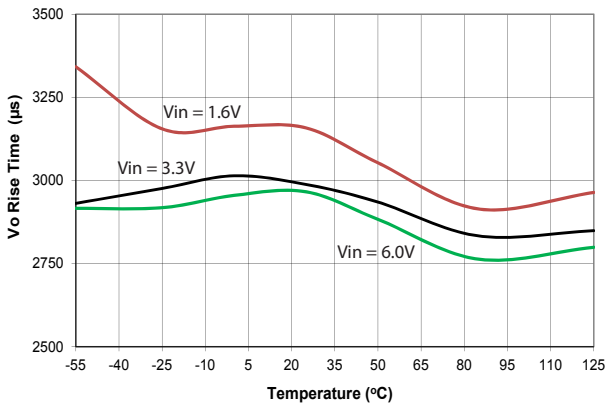

ENABLE Rising Threshold

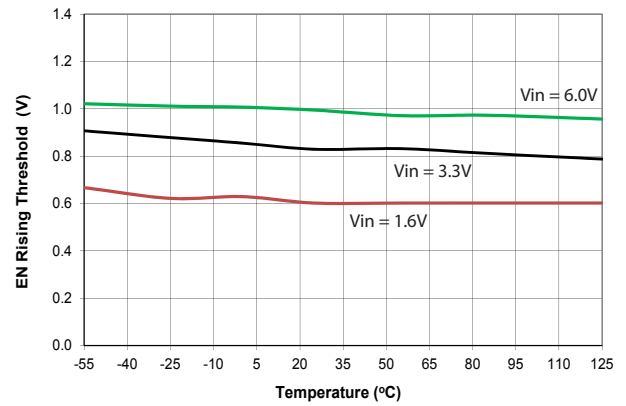

ENABLE Falling Threshold

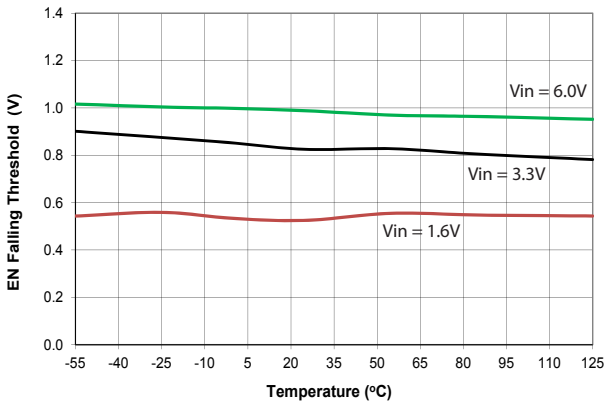

PG Threshold

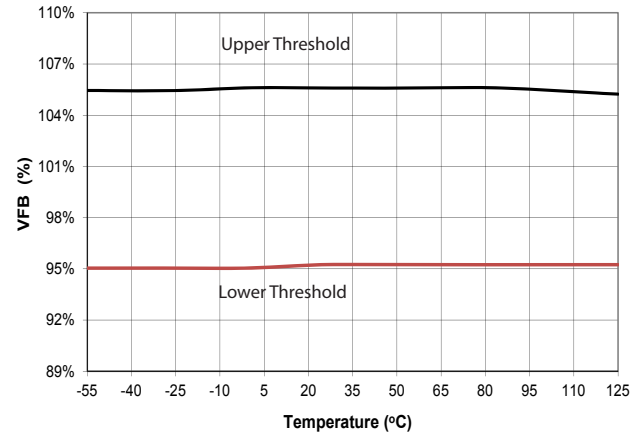

Typical Characteristics (Continued)

Unless noted otherwise $C_{IN} = 10\mu\text{F}/10\text{V X7R 0805}$, $C_{OUT} = 10\mu\text{F}/10\text{V X7R 0805}$.

Power Supply Ripple Rejection
 $V_{in} = 1.8\text{V}$, $V_o = 0.5\text{V}$, $I_o = 25\text{mA}$

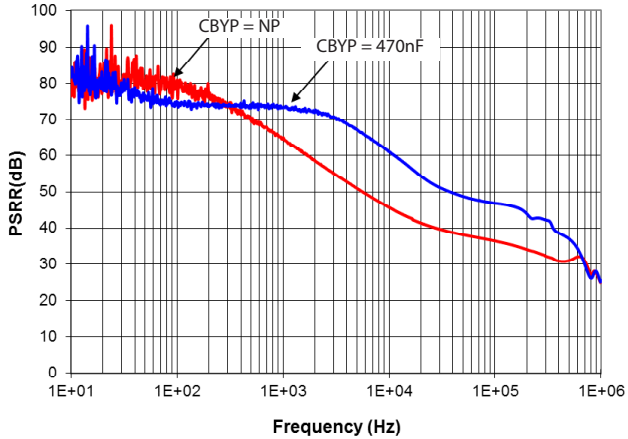

Power Supply Ripple Rejection
 $V_{in} = 1.8\text{V}$, $V_o = 0.5\text{V}$, $I_o = 1\text{A}$

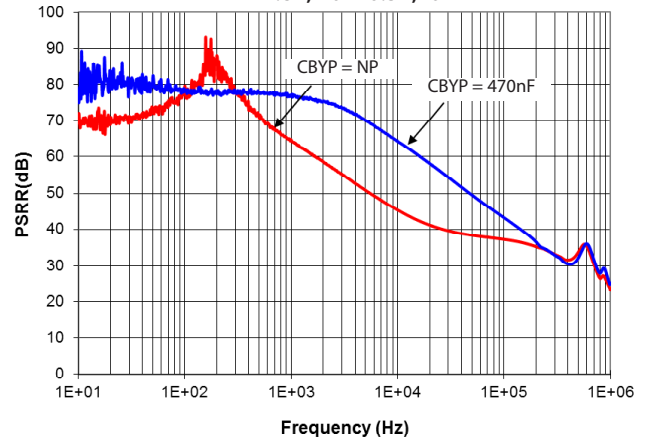

Output Spectral Noise Density
 $CBYP = NP$, $RL = 50\Omega$

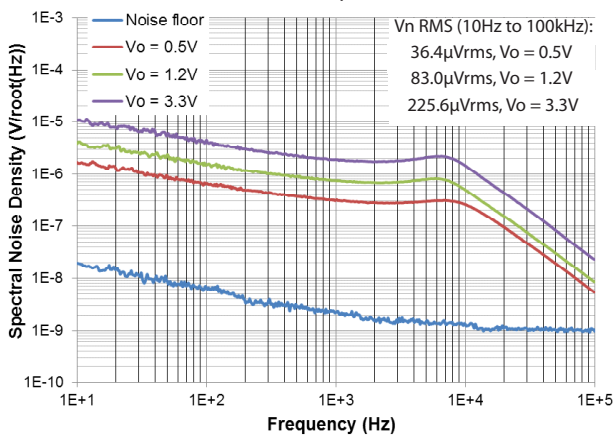

Output Spectral Noise Density
 $CBYP = 470\text{nF}$, $RL = 50\Omega$

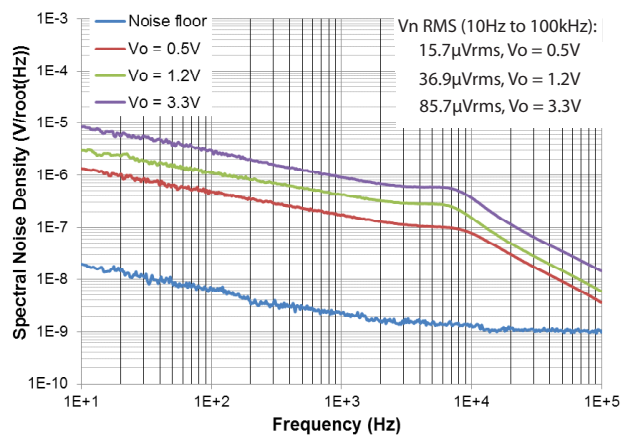

Applications Information

Introduction

The SC4212LM is intended for applications where high current capability and very low dropout voltage are required. It provides a very simple, low cost solution that uses very little PCB area. Additional features include an enable pin to allow for a very low power consumption in standby mode, and a fully adjustable output.

V_o Setting: $V_o = V_{REF}$

By connecting the FB pin directly to the VO pin, the output voltage will be regulated to the 0.5V internal reference. In this configuration, R2 should be 10kΩ.

V_o Setting with External Resistors

The use of 1% resistors, and designing for a current flow $\geq 50\mu\text{A}$ is recommended to ensure a well regulated output (thus $R_2 \leq 10\text{k}\Omega$). R_1 can then be calculated from

$$R_1 = R_2 (V_o - V_{REF}) / V_{REF}$$

Enable

Pulling this pin below 0.4V turns the regulator off, reducing the quiescent current to a fraction of its operating value. Driving this pin high enables the regulator. A pull up resistor $\leq 400\text{k}\Omega$ should be connected from this pin to the VIN pin in applications where the Enable pin is not driven from a control circuit.

Input Capacitor

A 10μF X7R ceramic capacitor, along with a 0.1μF ceramic decoupling capacitor is recommended to be placed directly next to the VIN pin. This allows for the device being some distance from the input source, reducing the input droop due to load transients and improving load transient response. Additional capacitance may be needed if large step, fast di/dt load transients are required or the LDO is located far away from the input source.

Output Capacitor

A 10μF X7R ceramic capacitor, along with a 0.1μF ceramic decoupling capacitor is recommended.

Soft-Start

Soft-start is achieved by using a voltage ramp as the voltage reference for the internal error amplifier during startup. This voltage ramp is created by an internal 2μA current source charging an external soft-start capacitor. When the voltage ramp reaches 500mV, the voltage reference for the internal error amplifier switches to the fixed 500mV V_{REF} . Thus, during soft-start, the output tracks the internal voltage ramp, which limits the input inrush current and provides a programmed soft-start profile for a wide range of applications. The soft-start time t_{SS} can be calculated with the below equation:

$$t_{SS} = 0.25 \times 10^6 C_{SS}$$

Power Good

The power good output is an open-drain output which requires a pull-up resistor. The SC4212LM features an active-high power good. During startup, the power good pin will not be pulled high until the soft-start is completed. In any case, the power good output will be low when the FB pin voltage is not within 10% of V_{REF} .

Over-Current and Thermal Shutdown

The over-current protection and thermal shutdown functions protect the regulator against damage due to excessive power dissipation. The SC4212LM is designed to current limit when the output current reaches 1.6A (typical). When the load exceeds 1.6A, the output voltage is reduced to maintain a constant current limit.

The thermal shutdown function limits the junction temperature to a maximum of 150°C (typical). Thermal shutdown turns off the regulator as the junction temperature reaches the high trip level of 150°C. When the junction temperature drops below 140°C (typical), the regulator is turned on once again.

Thermal Considerations

The power dissipation in the SC4212LM is roughly given by the following equation:

$$P_D = (V_{IN} - V_O) I_O$$

Applications Information (Continued)

The allowable power dissipation will be dependant upon the thermal impedance achieved in the application. The derating curve below is valid for the thermal impedance specified in the Thermal Information section on page 3.

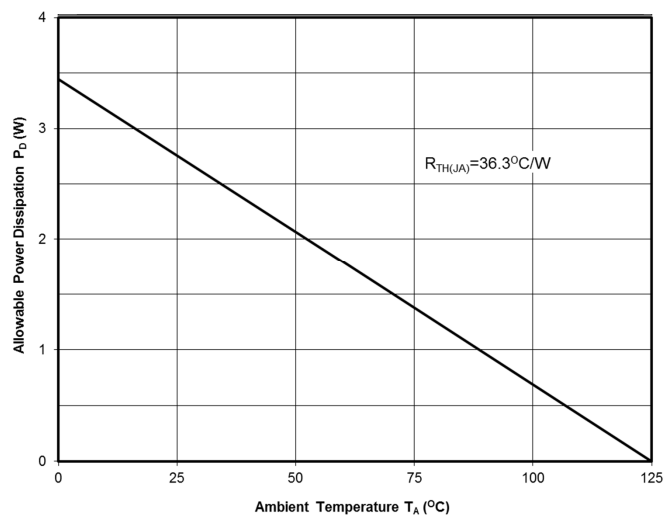
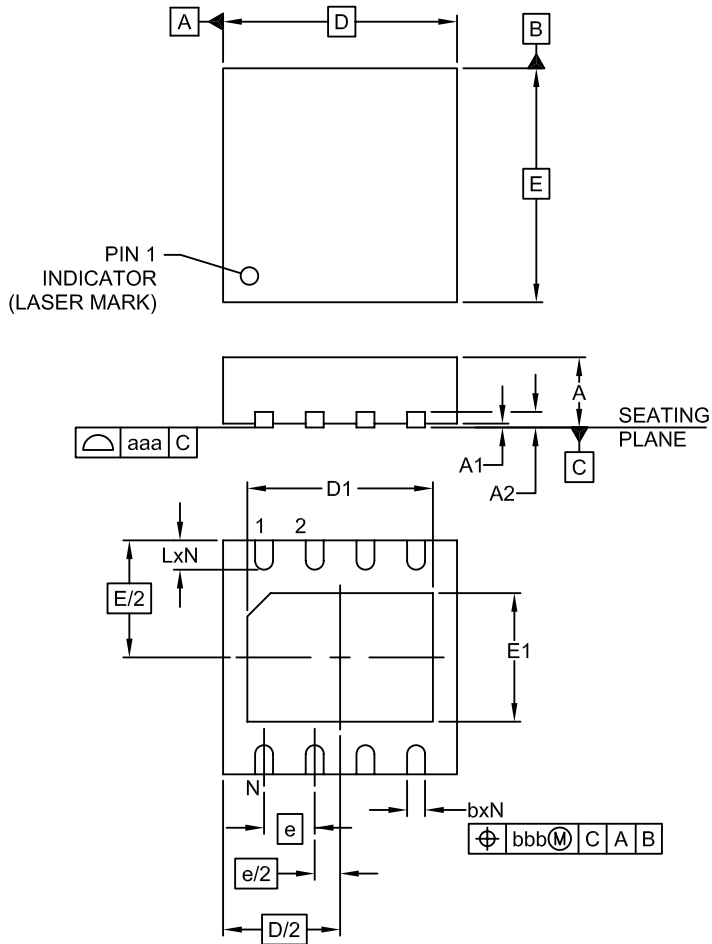

Figure 1. Power Derating Curve

Outline Drawing — 3mm x 3mm MLPD-8

DIM	INCHES			MILLIMETERS		
	MIN	NOM	MAX	MIN	NOM	MAX
A	.031	.035	.039	0.80	0.90	1.00
A1	.000	.001	.002	0.00	0.02	0.05
A2	-	(.008)	-	-	(0.20)	-
b	.010	.012	.014	0.25	0.30	0.35
D	.114	.118	.122	2.90	3.00	3.10
D1	.085	-	.098	2.15	-	2.48
E	.114	.118	.122	2.90	3.00	3.10
E1	.053	-	.069	1.35	-	1.75
e	.026 BSC			0.65 BSC		
L	.012	.016	.020	0.30	0.40	0.50
N	8			8		
aaa	.003			0.08		
bbb	.004			0.10		

NOTES:

1. CONTROLLING DIMENSIONS ARE IN MILLIMETERS (ANGLES IN DEGREES).
2. COPLANARITY APPLIES TO THE EXPOSED PAD AS WELL AS TERMINALS.

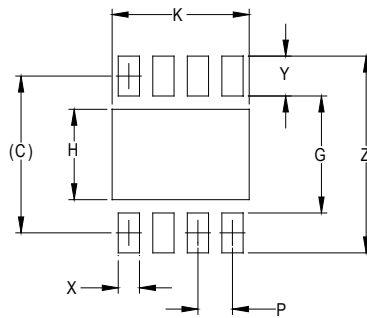
Land Pattern — 3mm x 3mm MLPD-8

DIMENSIONS		
DIM	INCHES	MILLIMETERS
C	(.116)	(2.95)
G	.087	2.20
H	.067	1.70
K	.102	2.58
P	.026	0.65
X	.016	0.40
Y	.030	0.75
Z	.146	3.70

NOTES:

1. CONTROLLING DIMENSIONS ARE IN MILLIMETERS (ANGLES IN DEGREES).
2. THIS LAND PATTERN IS FOR REFERENCE PURPOSES ONLY. CONSULT YOUR MANUFACTURING GROUP TO ENSURE YOUR COMPANY'S MANUFACTURING GUIDELINES ARE MET.
3. THERMAL VIAS IN THE LAND PATTERN OF THE EXPOSED PAD SHALL BE CONNECTED TO A SYSTEM GROUND PLANE. FAILURE TO DO SO MAY COMPROMISE THE THERMAL AND/OR FUNCTIONAL PERFORMANCE OF THE DEVICE.

© Semtech 2017

All rights reserved. Reproduction in whole or in part is prohibited without the prior written consent of the copyright owner. The information presented in this document does not form part of any quotation or contract, is believed to be accurate and reliable and may be changed without notice. No liability will be accepted by the publisher for any consequence of its use. Publication thereof does not convey nor imply any license under patent or other industrial or intellectual property rights. Semtech assumes no responsibility or liability whatsoever for any failure or unexpected operation resulting from misuse, neglect improper installation, repair or improper handling or unusual physical or electrical stress including, but not limited to, exposure to parameters beyond the specified maximum ratings or operation outside the specified range.

SEMTECH PRODUCTS ARE NOT DESIGNED, INTENDED, AUTHORIZED OR WARRANTED TO BE SUITABLE FOR USE IN LIFE-SUPPORT APPLICATIONS, DEVICES OR SYSTEMS OR OTHER CRITICAL APPLICATIONS. INCLUSION OF SEMTECH PRODUCTS IN SUCH APPLICATIONS IS UNDERSTOOD TO BE UNDERTAKEN SOLELY AT THE CUSTOMER'S OWN RISK. Should a customer purchase or use Semtech products for any such unauthorized application, the customer shall indemnify and hold Semtech and its officers, employees, subsidiaries, affiliates, and distributors harmless against all claims, costs damages and attorney fees which could arise.

Notice: All referenced brands, product names, service names and trademarks are the property of their respective owners.

Contact Information

Semtech Corporation
Power Management Products Division
200 Flynn Road, Camarillo, CA 93012
Phone: (805) 498-2111 Fax: (805) 498-3804

www.semtech.com